

PROJECT
Bike Shelter Project

TITLE
Bike Shelter Design 3/4/18 Extended Side View

APPROVED	SIZE	CODE	DWG NO	REV
CHECKED	B			
DRAWN Adam Peloquin 4/3/18	SCALE 1:16	WEIGHT	SHEET 1/5	

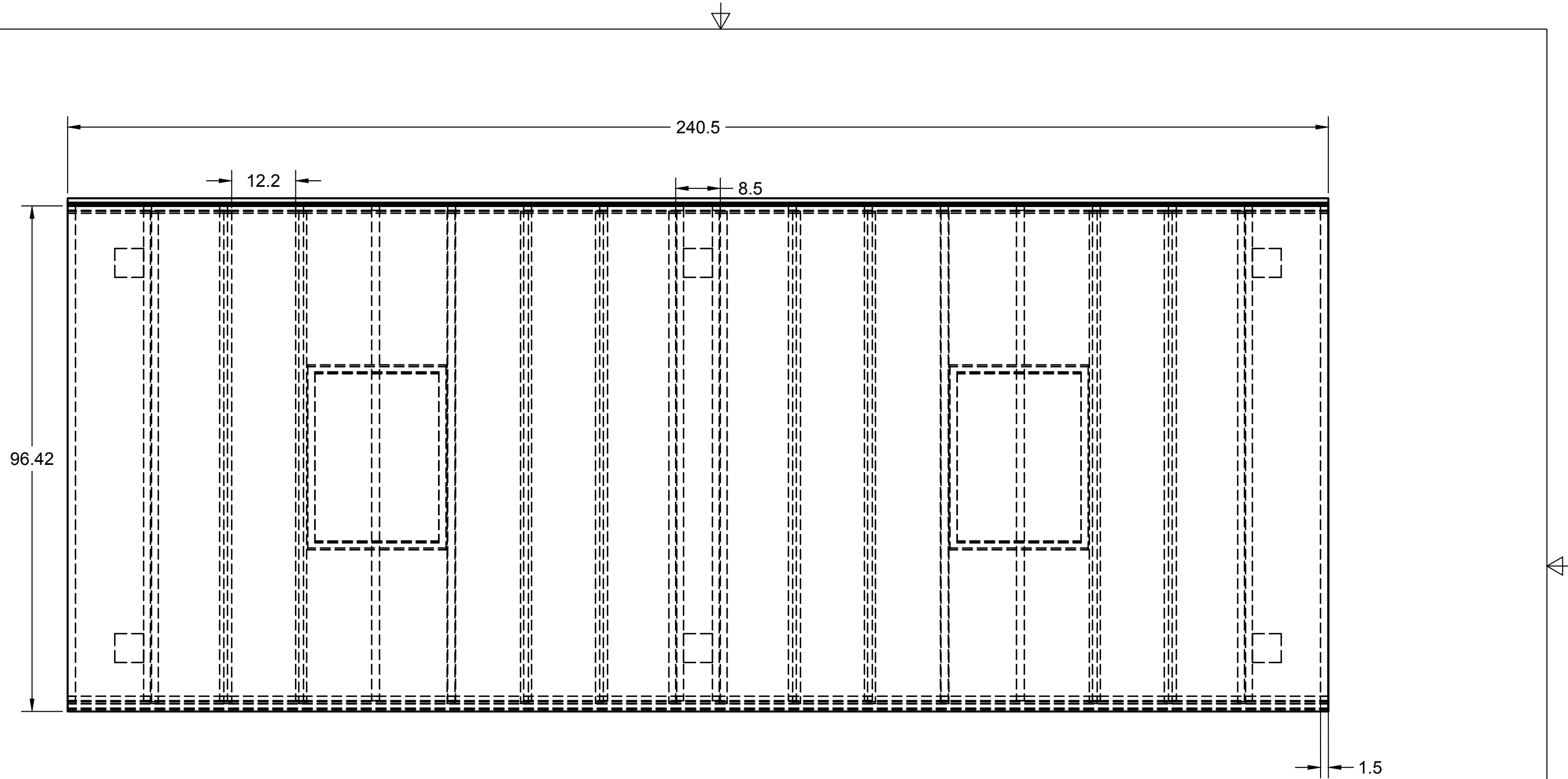

		PROJECT			
		Bike Shelter Project			
		TITLE			
		Bike Shelter Design 3/4/18 Extended Top View			
APPROVED		SIZE	CODE	DWG NO	REV
CHECKED		B			
DRAWN	Adam Peloquin	4/3/18	SCALE 1:50	WEIGHT	SHEET 2/5

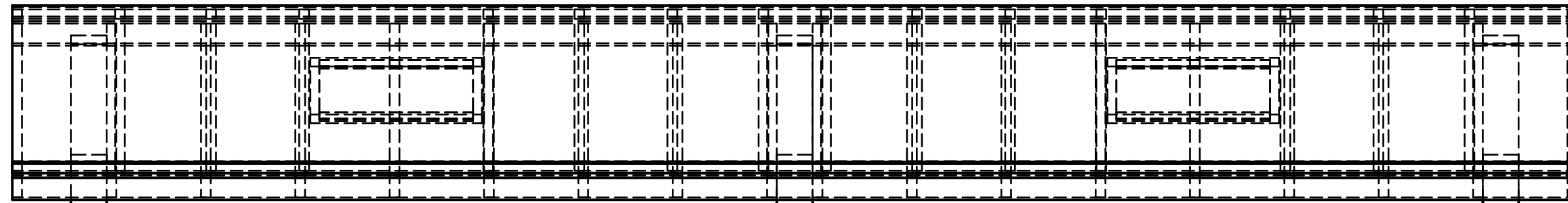

7.5
13

5.5
103

		PROJECT Bike Shelter Project			
		TITLE Bike Shelter Design 3/4/18 Extended Back View			
APPROVED	SIZE	CODE	DWG NO		REV
CHECKED	B				
DRAWN	Adam Peloquin	4/3/18	SCALE 1:20	WEIGHT	SHEET 3/5

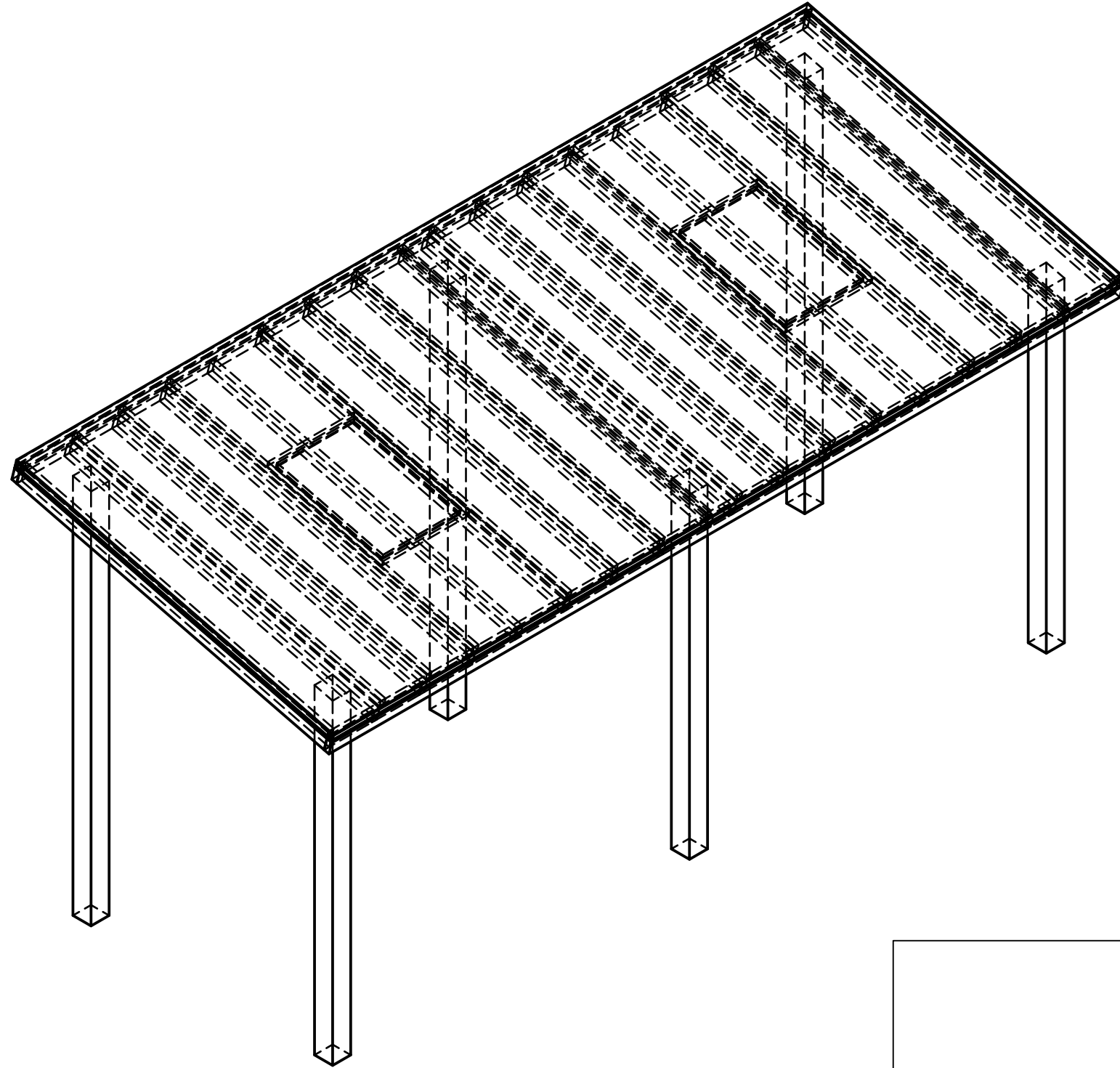

		PROJECT		
		Bike Shelter Project		
		TITLE		
		Bike Shelter Design 3/4/18 Extended Perspective View		
APPROVED	SIZE	CODE	DWG NO	REV
CHECKED	B			
DRAWN	Adam Peloquin	4/3/18	SCALE 1:30	WEIGHT
			SHEET 4/5	

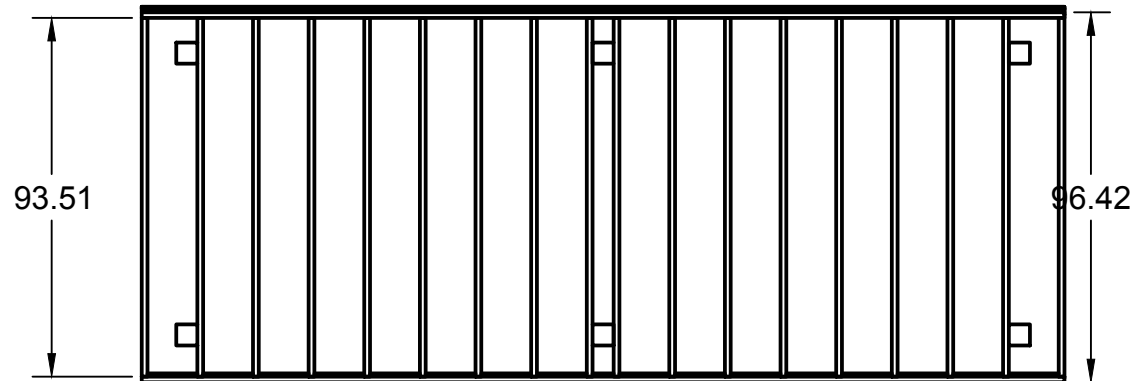
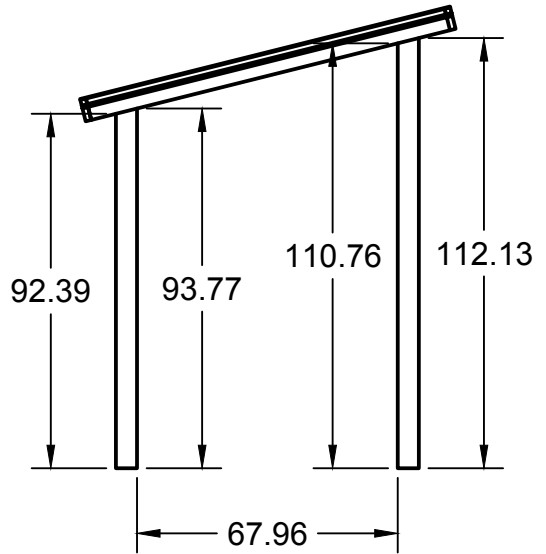
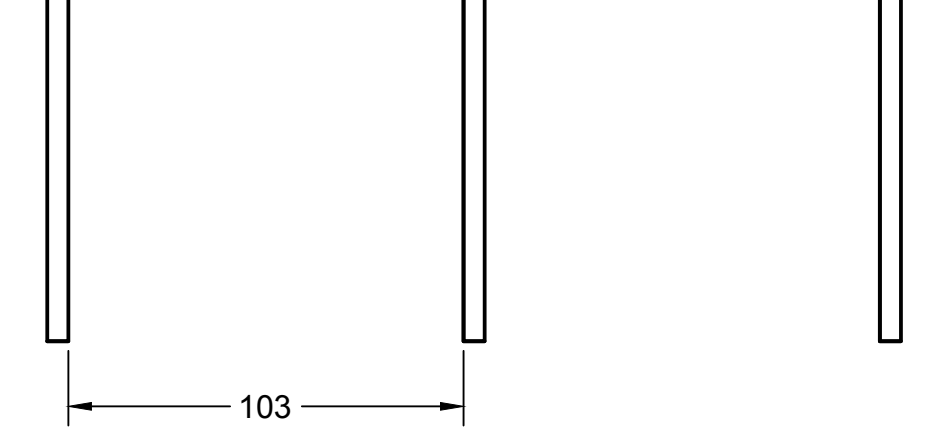
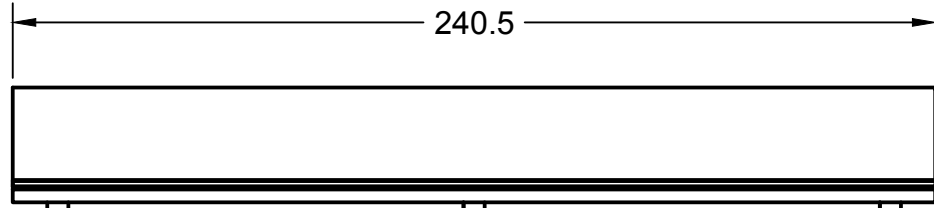

		PROJECT Bike Shelter Project			
		TITLE Bike Shelter Design 3/4/18 Extended Projected View			
APPROVED	SIZE	CODE	DWG NO		REV
CHECKED	B				
DRAWN	Adam Peloquin	4/3/18	SCALE 1:50	WEIGHT	SHEET 5/5